

EXTREMELY EASY TO INSTALL

MORE PROFITABLE FOR INSTALLER
 INSTALLATION IS UP TO 3x FASTER
 CAN BE USED WITHOUT FLOOR PLIERS

PATENTED



CANADIAN DESIGN
 WWW.TLPRO.CO

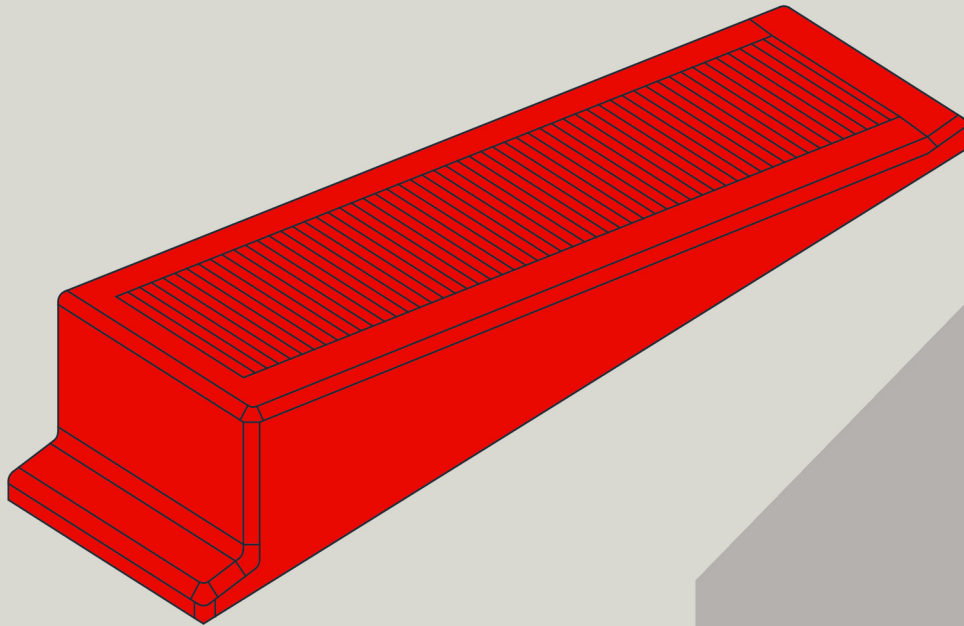

CONSUMPTION PER SQUARE METER

TILE LOCK WEDGES

ACM	10	15	20	25	30	33	40	45	50	60	80	90	100	120	8CM
10	200														
15	133	69													
20	100	67	50												
25	80	53	40	32											
30	100	67	50	40	44										
33	91	61	45	36	40	37									
40	75	50	37	30	33	30	25								
45	67	44	33	27	30	27	22	20							
50	60	40	30	24	27	24	20	18	16						
60	50	33	25	20	22	20	17	15	13	11					
80	50	33	25	20	21	19	16	14	12	10	9				
90	44	30	22	18	19	17	14	12	11	9	8	7			
100	50	33	25	20	20	18	15	13	12	10	9	8	8		
120	42	28	31	17	17	15	13	11	10	8	7	6	7	6	

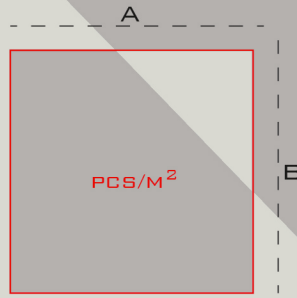

A (60cm) x B (25cm) = 20PCS

SPACER FROM: 1.5 MM
 TILE THICKNESS: MIN 3MM / MAX 12MM

100 PCS +/- 1%

TILE LOCK LEVELING SYSTEM

HOW TO USE

STEP 1

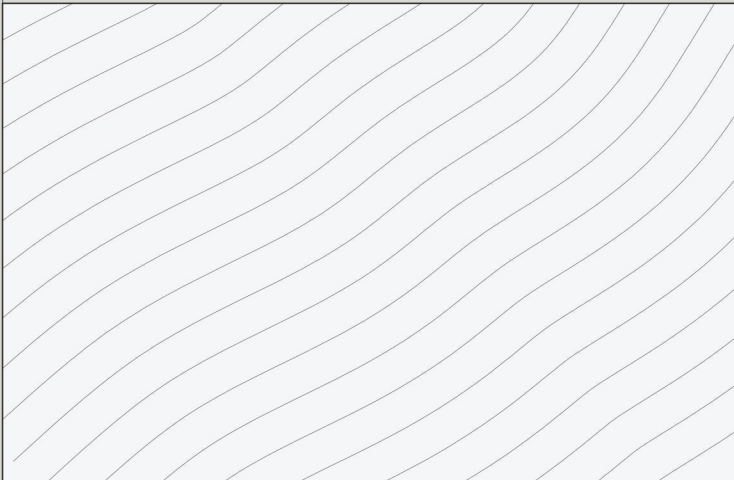

APPLY TILE ADHESIVE EVENLY ON SURFACE.

STEP 2

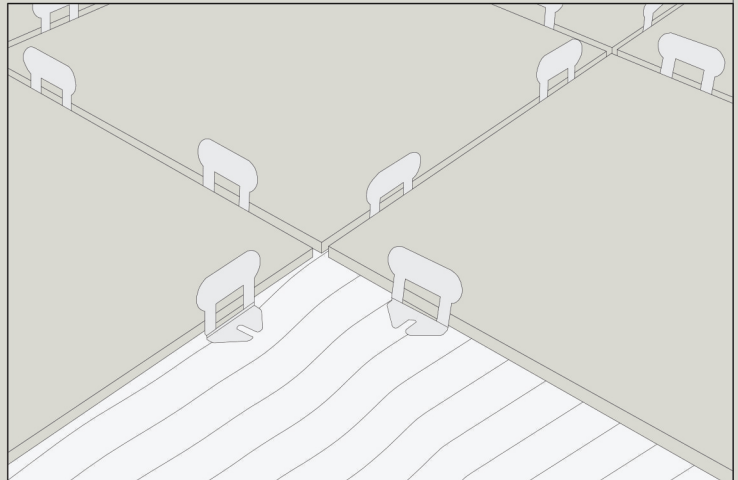

PLACE TILES AND INSERT CLIPS. (SEE CONSUMMATION TABLE FOR RECOMMENDED AMOUNT OF CLIPS)

STEP 3

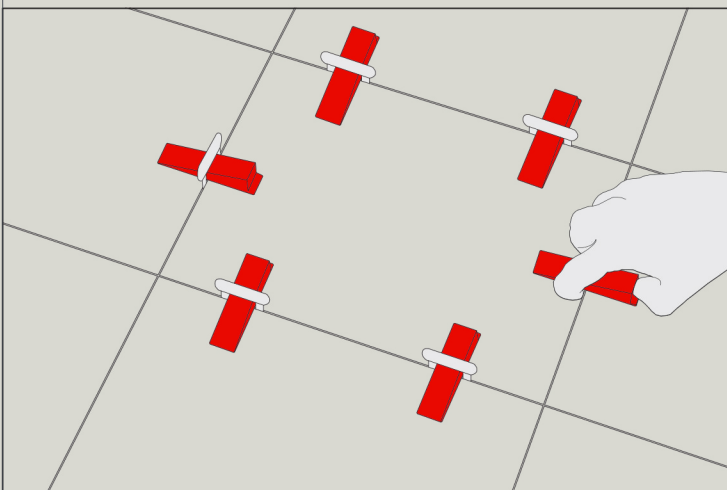

INSERT WEDGE INTO CLIP, PLACE THUMB ON BACK SIDE OF WEDGE AND PLACE MIDDLE AND FOREFINGERS ON CLIP. PRESS WEDGE WITH THUMB THROUGH CLIP WHILE PULLING BACK WITH MIDDLE AND FOREFINGER UNTIL TILES LEVEL. (FOR TILES LARGER THAN 60X 60CM ITS RECOMMENDED TO USE LEVELING PLIERS).

STEP 4

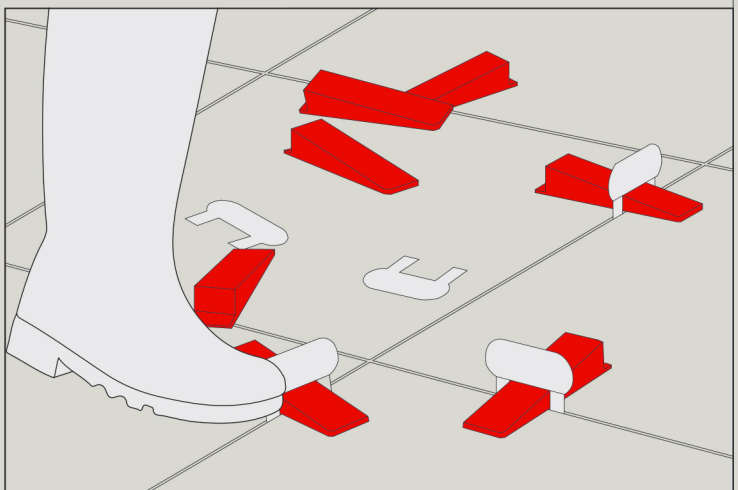

AFTER ADHESIVE DRIES, BREAK OF LOOSE ENDS WITH RUBBER HAMMER OR KICK OFF WITH BOOT.

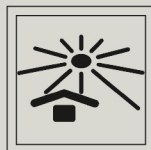

DESIGNED BY TILE LOCK CANADA.

PRODUCED IN SERBIA.

EXPORTER & DISTRIBUTER: EURIS DOO, SAVE MASKOVICA 3, 11000 BEOGRAD, SERBIA

PHONE +381 11 6304 800, EMAIL: TRADE@TLPRO.CO

PACKAGE DESIGN BY: "OUT-LINE", RUOUTLINED@GMAIL.COM